

CUSTOMER REFERENCE DRAWING

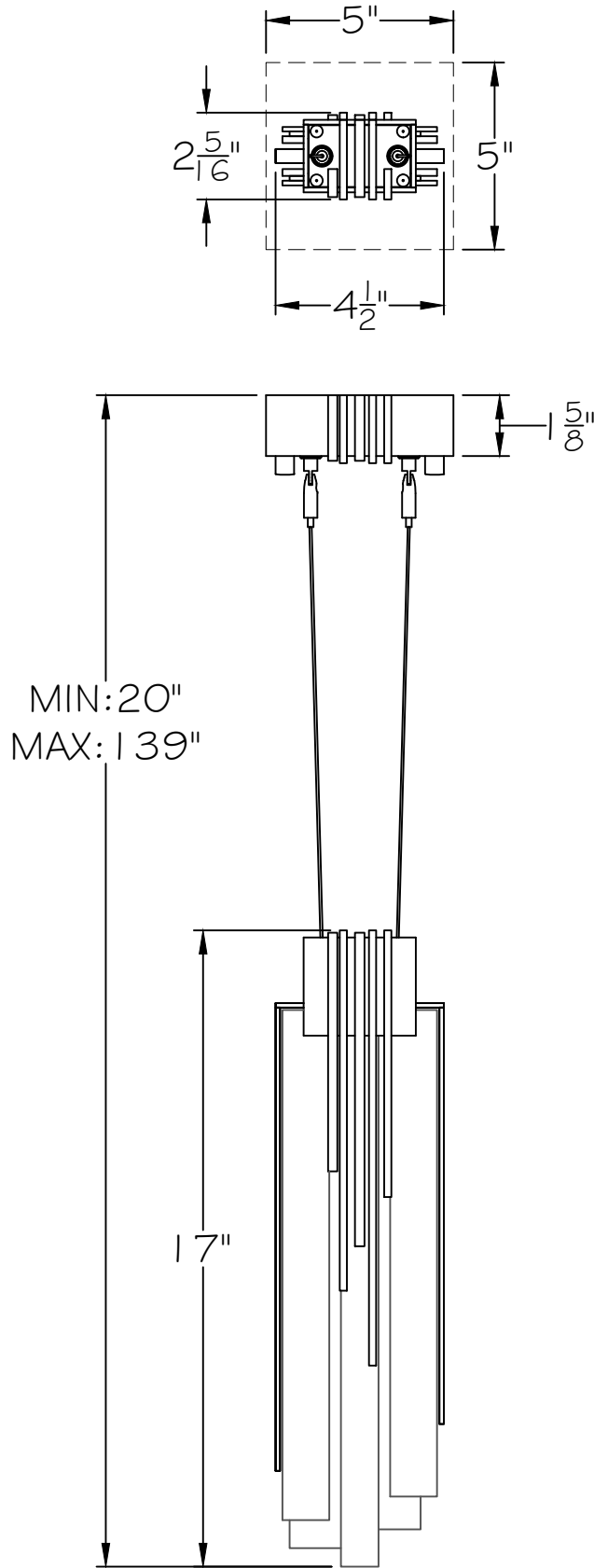

STYLE CONFIGURATIONS:

-51 (SFT GOLD/CLEAR GLS)

-52 (SFT GOLD/MULTI-TONE GLS)

-61 (MID.STEEL/CLEAR GLS)

-62 (MID.STEEL/MULTI-TONE GLS)



This drawing, specifications and the product depicted are the exclusive property of Fine Art Handcrafted Lighting®. In compliance with US copyright and patent requirements, notice is hereby given that this document and the product depicted shall not be copied, altered or used in any manner without the expressed written consent of Fine Art Handcrafted Lighting®.

www.finearthl.com Tel:(305) 821-3850
FINE ART LAMPS®

STYLE NUMBER:

100081

DATE:

3/25/25